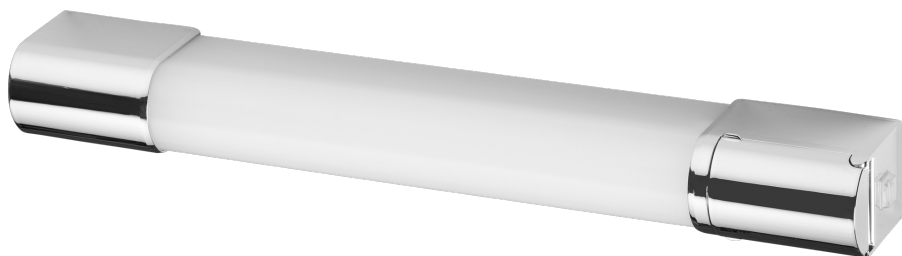


## INSTALLATION & MAINTENANCE MANUAL

---



230V  
50Hz

IP  
44



## GENERAL INSTRUCTIONS

These instructions should be read carefully and retained after installation by the end user for future reference and maintenance.

These instructions should be used to aid installation of the following products:

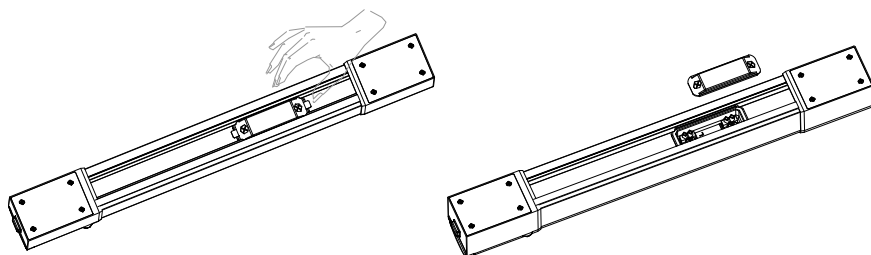
**BWLED6 / BWLED7**

## SAFETY

- Installation of this luminaire should only be carried out by a qualified electrician or competent person to the current IEE Wiring Regulations (BS7671)
- Please isolate mains prior to installation/maintenance
- Check the total load on the circuit (including when this luminaire is fitted) does not exceed the rating of the circuit cable, fuse or circuit breaker
- Please note the IP (Ingress of Protection) rating of this luminaire when deciding the location for installation
- This product is Class I and requires an earth
- This product is IP44 rated
- This product is non-dimmable

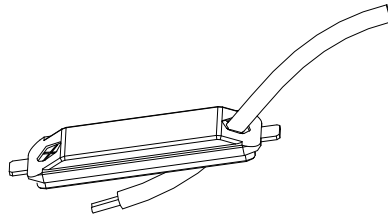
## INSTALLATION

- Provide power to the point of installation
- Remove wall mounting clips and use as a template ensuring correct fixtures are used for the surface. Drill holes ensuring they do not infringe with electrical cables, water/gas pipes or ceiling joists (space the clips evenly so that they can support the weight of the luminaire)
- Remove the rubber terminal access cover (see Fig 1)



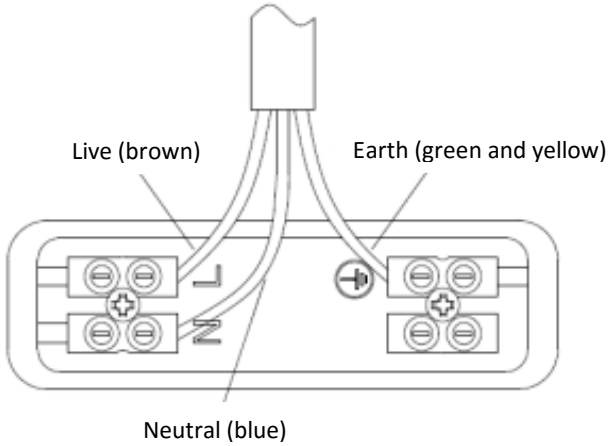
**Fig 1**

- Make a hole in the rubber terminal access cover and feed cable through (see Fig 2)



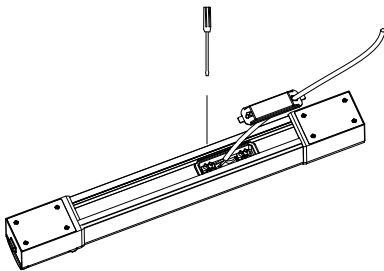
**Fig 2**

- Wire the mains cable ensuring correct polarity is observed - Live (brown), Neutral (blue) and Earth (green and yellow) (see Fig 3)

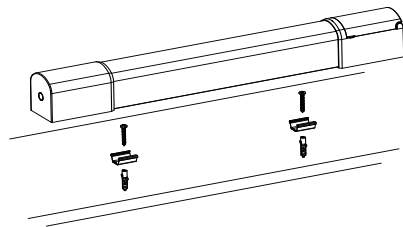


**Fig 3**

- Push the terminal cover onto the rear of the luminaire (see Fig 4)



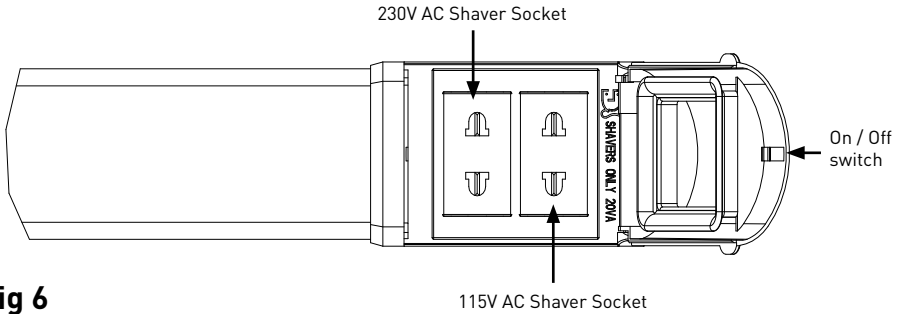
**Fig 4**



**Fig 5**

- Fix the luminaire to the wall clips (see Fig 5)
- Switch on power supply and check for correct operation

# SHAVER SOCKET



**Fig 6**

## WARNING

Shaver sockets will remain live when luminaire is switched off

This product must be disconnected from the circuit if subjected to any high voltage or insulation resistance testing. Irreparable damage will occur if this instruction is not followed.

## GENERAL

The unit should be recycled in the correct manner when it reaches the end of its life. Check local authorities for where facilities exist.

Clean with a soft dry cloth only, do not use aggressive cleaning products or solvents which may damage the fitting.

## WARRANTY

This product has a warranty of 3 years from date of purchase. Failure to install this product in accordance with the current edition of the IEE Wiring Regulations, improper use, or removal of the batch codes will invalidate the warranty. If this product should fail within its warranty period it should be returned to the place of purchase for a free of charge replacement. ML Accessories does not accept responsibility for any installation costs associated with the replacement product. Your statutory rights are not affected. ML Accessories reserve the right to alter product specification without prior notice.