

ITEM

Lampada a sospensione multipla
con Rose-one rettangolare
Multi-pendant lamp
with rectangular Rose-one

SPM2RE

220 - 240V
MAX 2 x 25W

CL. I CE 

SE IL CAVO FLESSIBILE ESTERNO DI QUESTO APPARECCHIO VIENE DANNEGGIATO
DEVE ESSERE SOSTITUITO DAL COSTRUTTORE O DAL SUO SERVIZIO ASSISTENZA
O DA PERSONALE QUALIFICATO EQUIVALENTE AL FINE DI EVITARE PERICOLI

IF THE EXTERNAL FLEXIBLE CABLE OF THIS LUMINAIRE IS DAMAGED, IT SHALL BE
EXCLUSIVELY REPLACED BY THE MANUFACTURER OR HIS SERVICE AGENT OR
A SIMILAR QUALIFIED PERSON IN ORDER TO AVOID HAZARDS

1

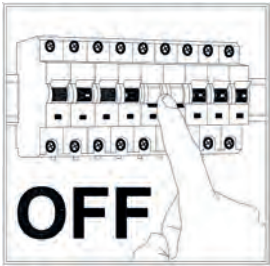

2

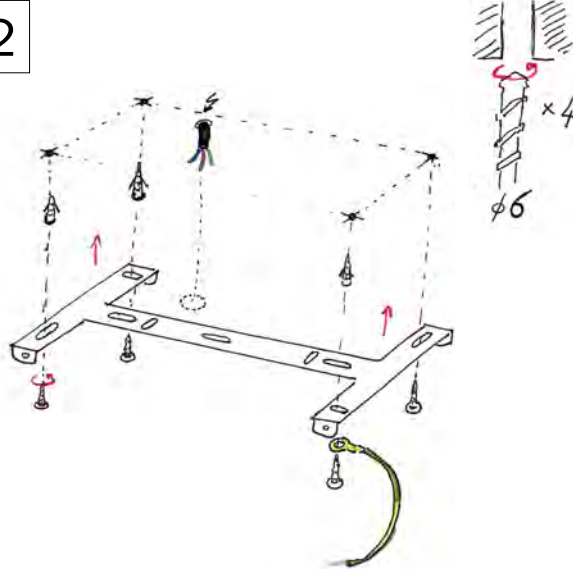

3

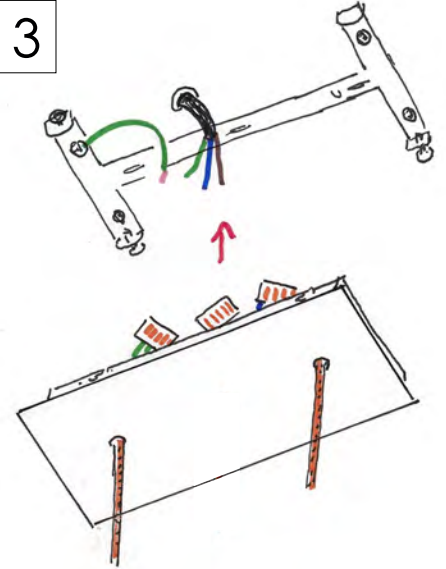

4

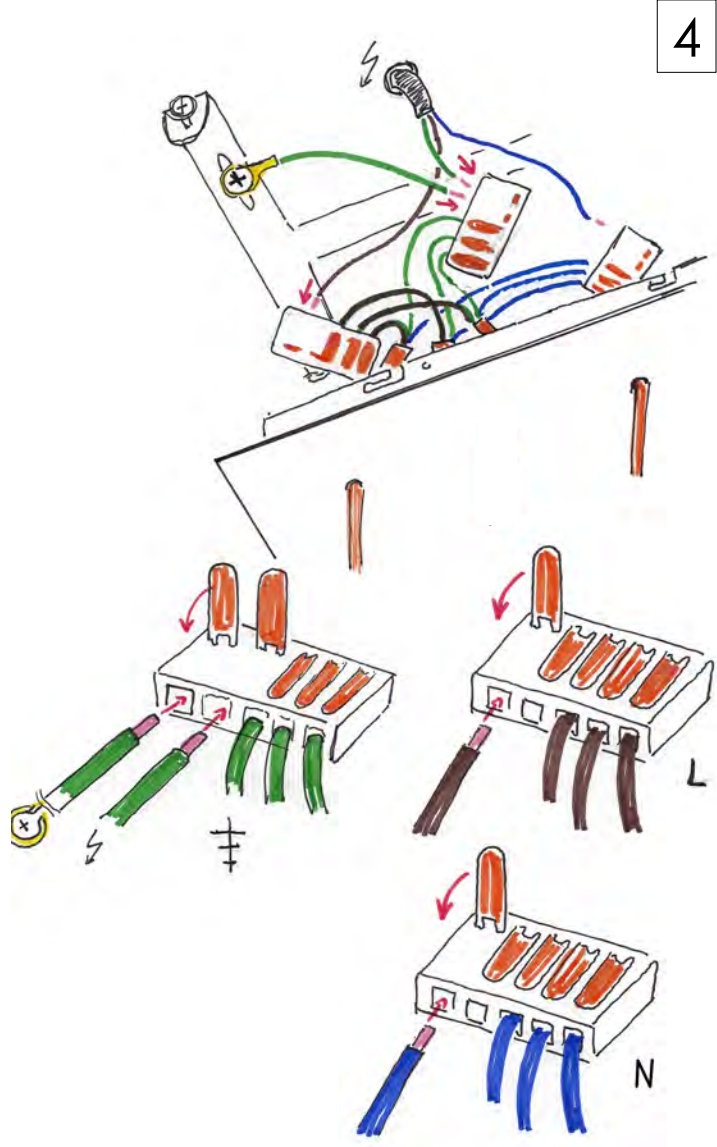

5

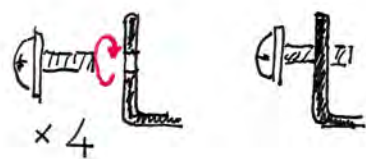

6

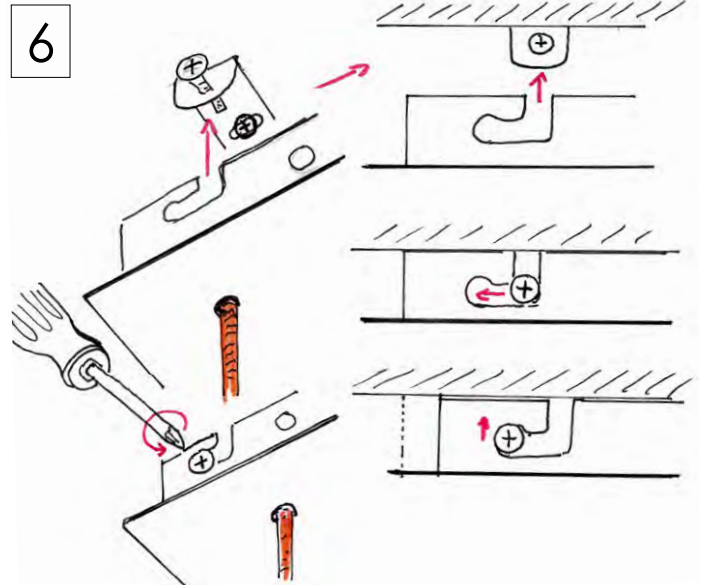

7

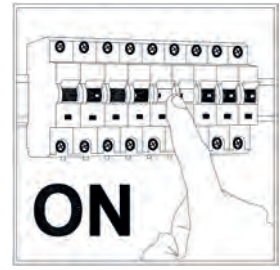

ITEM

Lampada a sospensione multipla
con Rose-one rettangolare
Multi-pendant lamp
with rectangular Rose-one

SPM3RE

220 - 240V
MAX 3 x 25W

CL. I CE 

SE IL CAVO FLESSIBILE ESTERNO DI QUESTO APPARECCHIO VIENE DANNEGGIATO DEVE ESSERE SOSTITUITO DAL COSTRUTTORE O DAL SUO SERVIZIO ASSISTENZA O DA PERSONALE QUALIFICATO EQUIVALENTE AL FINE DI EVITARE PERICOLI

IF THE EXTERNAL FLEXIBLE CABLE OF THIS LUMINAIRE IS DAMAGED, IT SHALL BE EXCLUSIVELY REPLACED BY THE MANUFACTURER OR HIS SERVICE AGENT OR A SIMILAR QUALIFIED PERSON IN ORDER TO AVOID HAZARDS

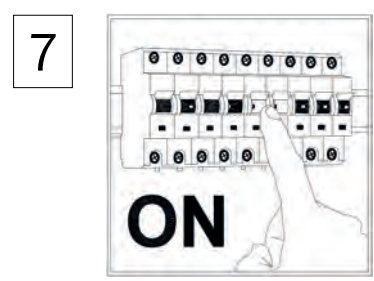
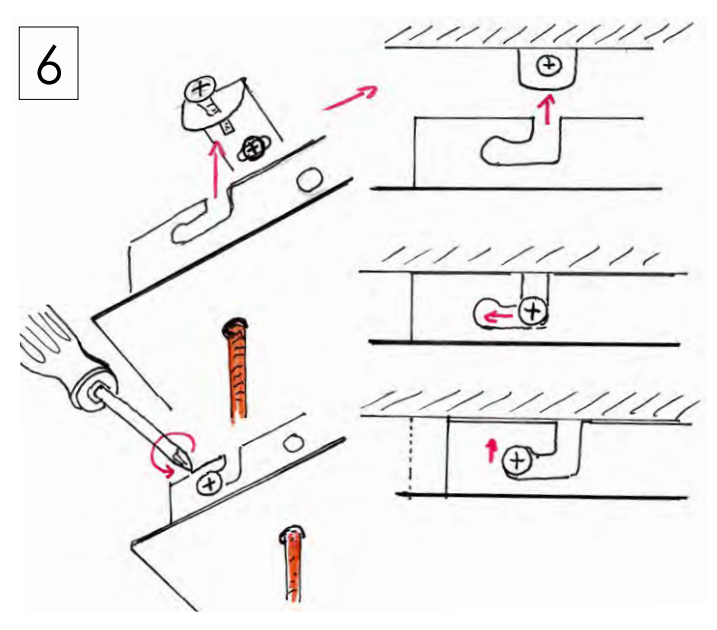
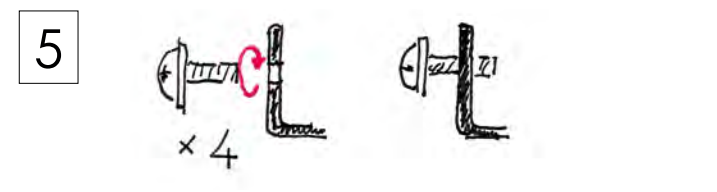
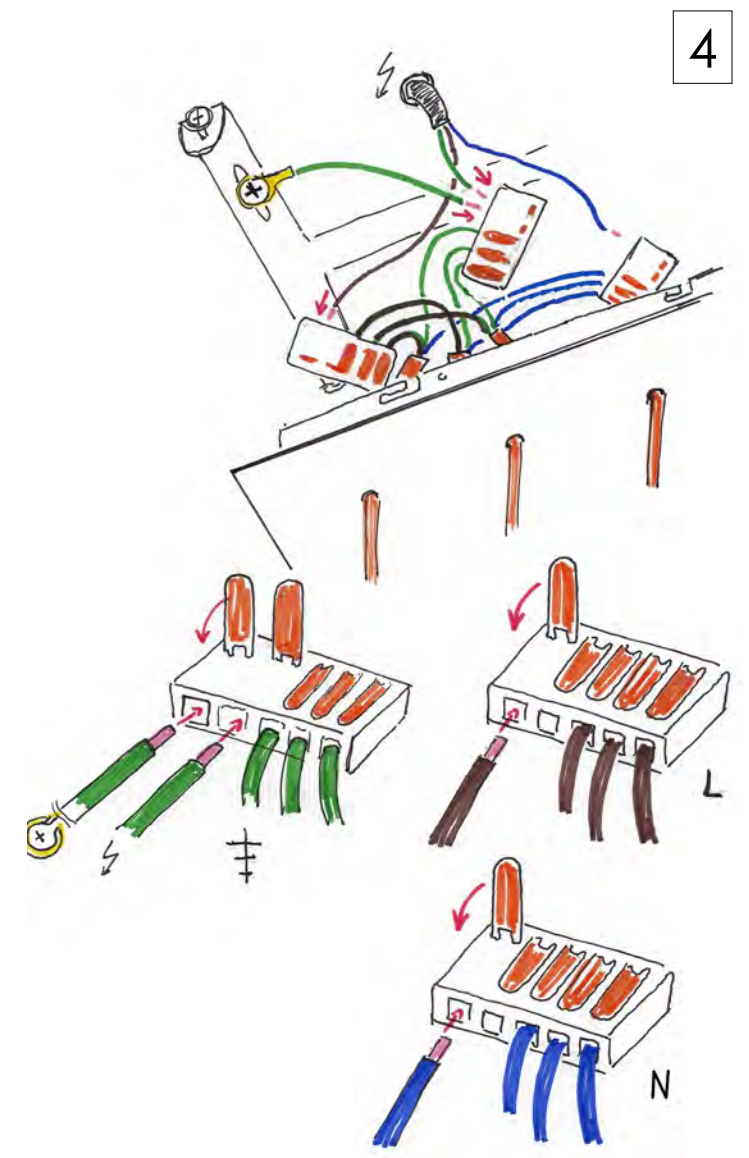
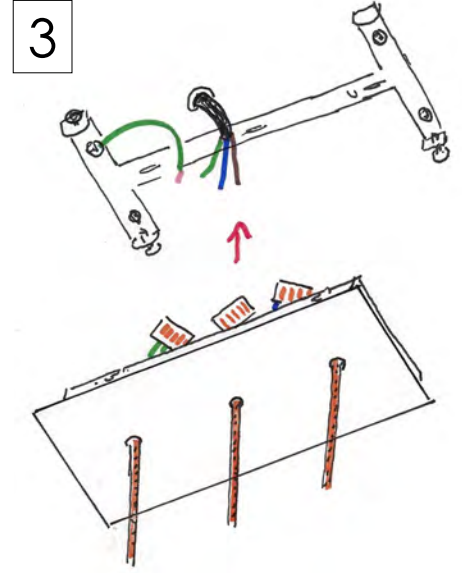
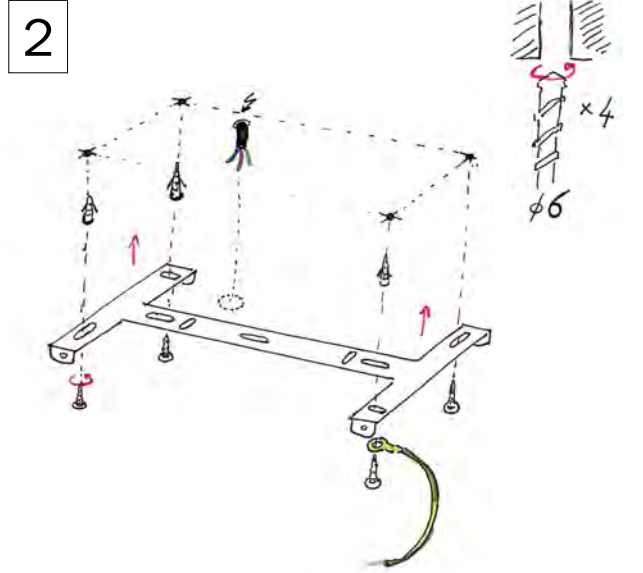
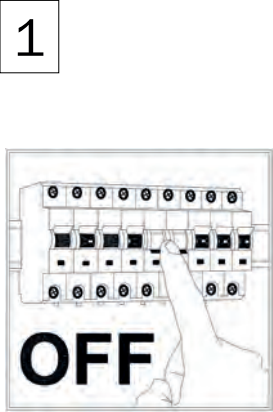

ITEM

Lampada a sospensione multipla
con Rose-one rettangolare
Multi-pendant lamp
with rectangular Rose-one

SPM4RE

220 - 240V
MAX 4 x 25W

CL. I CE 

SE IL CAVO FLESSIBILE ESTERNO DI QUESTO APPARECCHIO VIENE DANNEGGIATO
DEVE ESSERE SOSTITUITO DAL COSTRUTTORE O DAL SUO SERVIZIO ASSISTENZA
O DA PERSONALE QUALIFICATO EQUIVALENTE AL FINE DI EVITARE PERICOLI

IF THE EXTERNAL FLEXIBLE CABLE OF THIS LUMINAIRE IS DAMAGED, IT SHALL BE
EXCLUSIVELY REPLACED BY THE MANUFACTURER OR HIS SERVICE AGENT OR
A SIMILAR QUALIFIED PERSON IN ORDER TO AVOID HAZARDS

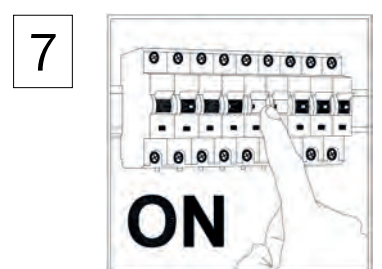
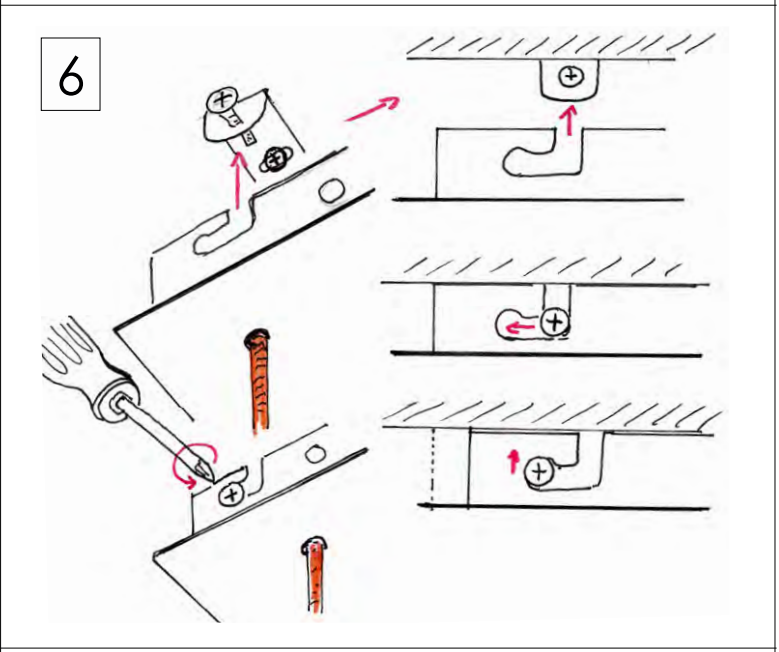
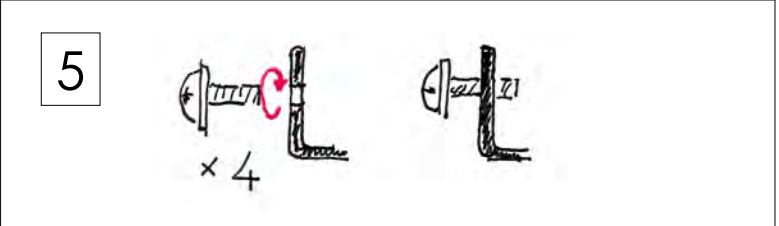
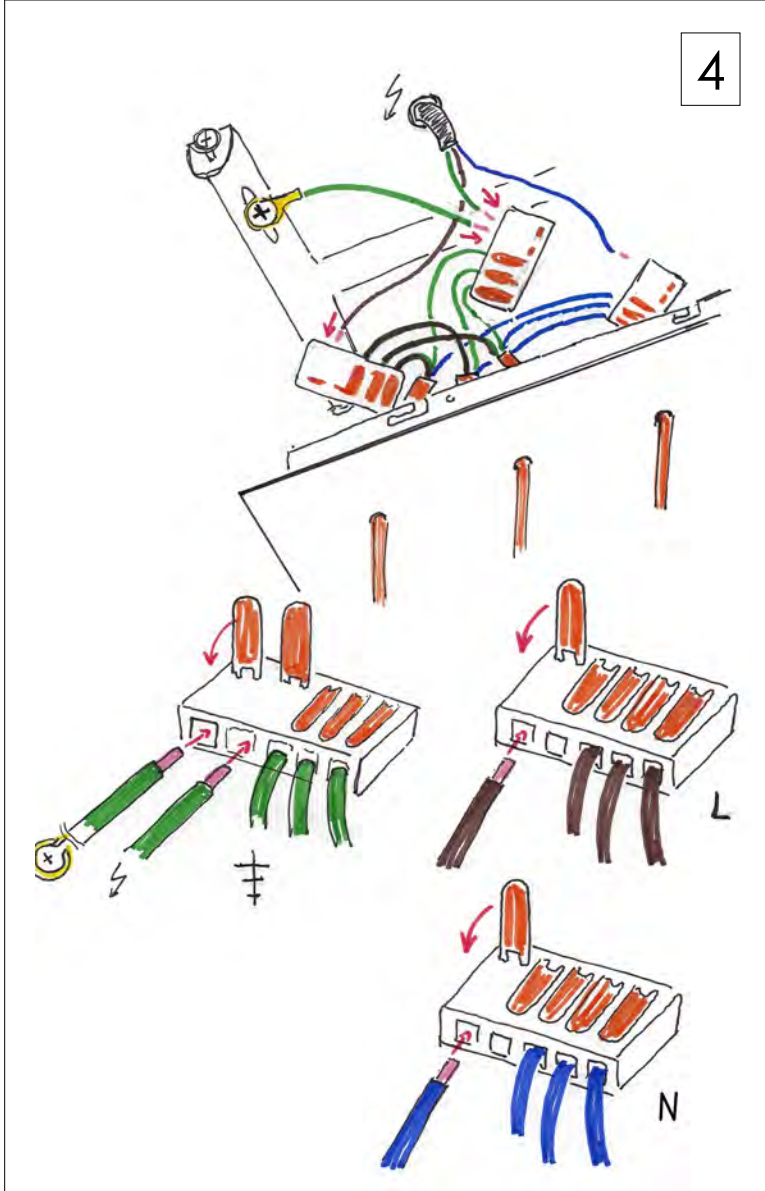
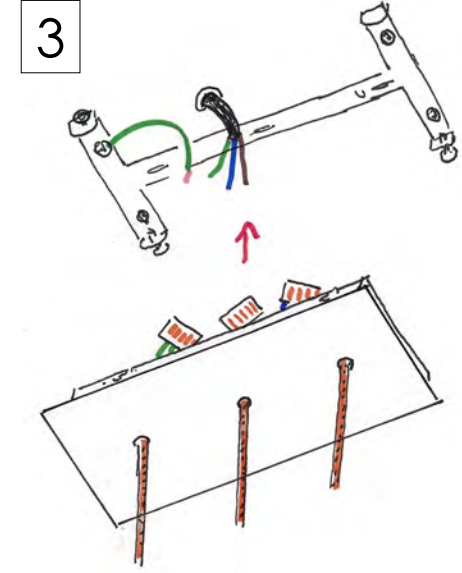
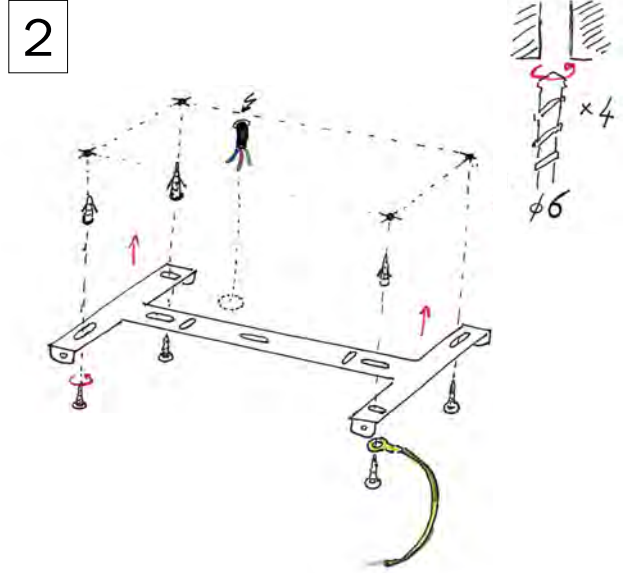
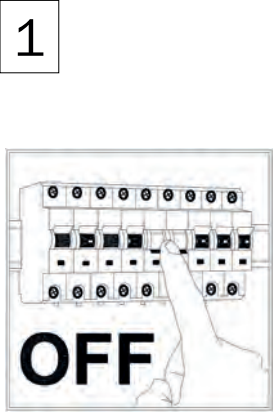

ITEM

Lampada a sospensione multipla
con Rose-one rettangolare
Multi-pendant lamp
with rectangular Rose-one

SPM5RE

220 - 240V
MAX 5 x 25W

CL. I CE 

SE IL CAVO FLESSIBILE ESTERNO DI QUESTO APPARECCHIO VIENE DANNEGGIATO DEVE ESSERE SOSTITUITO DAL COSTRUTTORE O DAL SUO SERVIZIO ASSISTENZA O DA PERSONALE QUALIFICATO EQUIVALENTE AL FINE DI EVITARE PERICOLI

IF THE EXTERNAL FLEXIBLE CABLE OF THIS LUMINAIRE IS DAMAGED, IT SHALL BE EXCLUSIVELY REPLACED BY THE MANUFACTURER OR HIS SERVICE AGENT OR A SIMILAR QUALIFIED PERSON IN ORDER TO AVOID HAZARDS

1

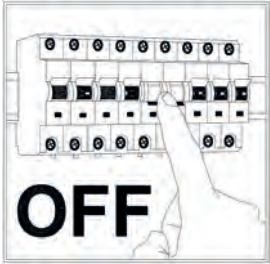

2

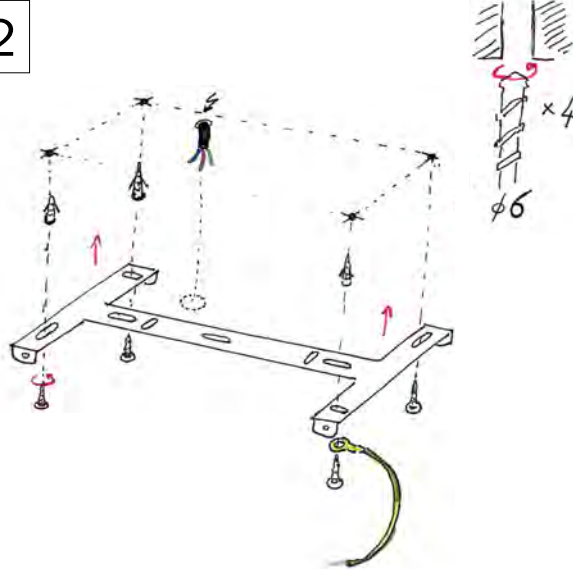

3

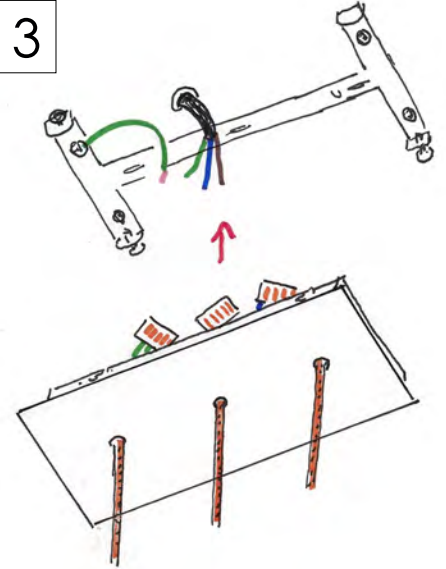

4

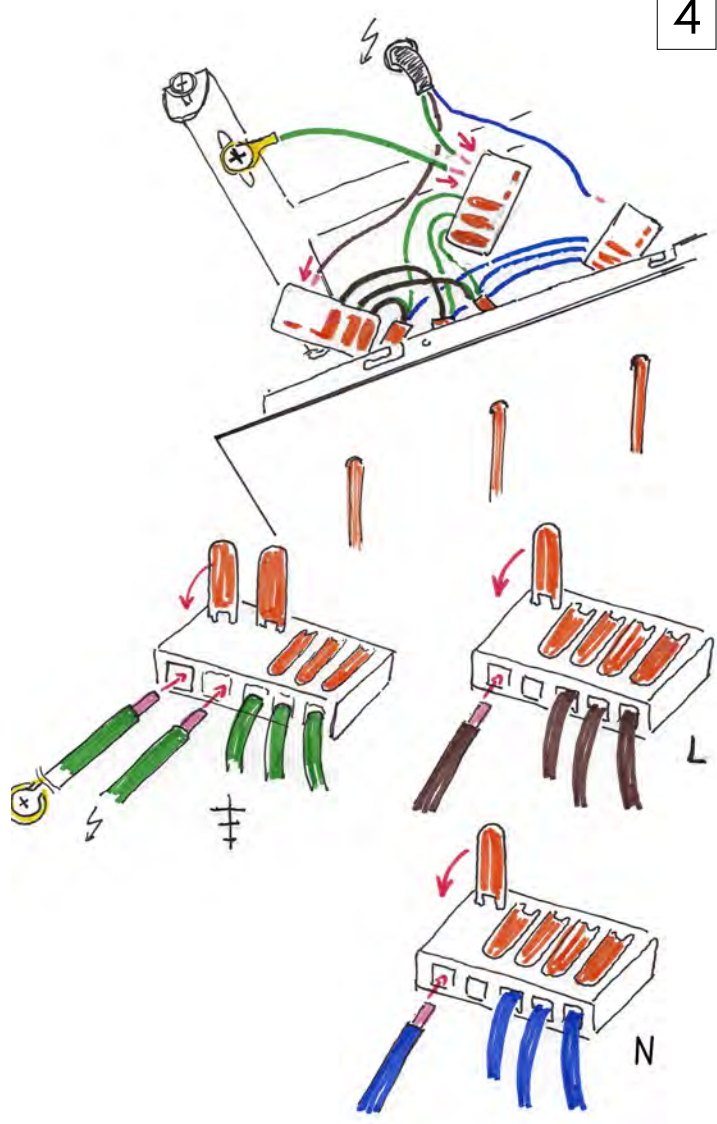

5

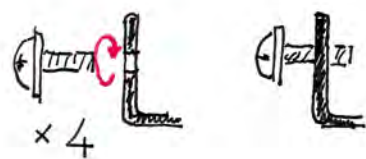

6

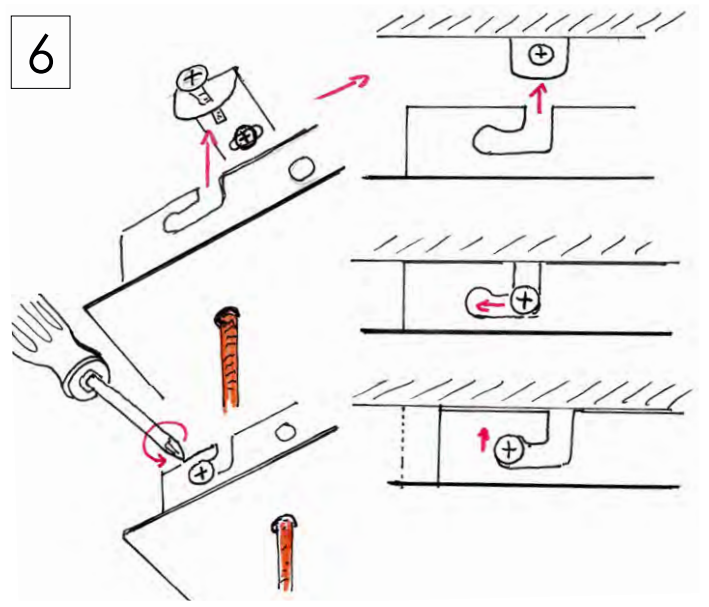

7

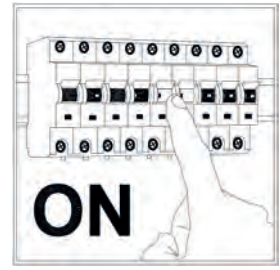

ITEM

Lampada a sospensione multipla
con Rose-one rettangolare
Multi-pendant lamp
with rectangular Rose-one

SPM6RE

220 - 240V
MAX 6 x 25W

CL. I CE 

SE IL CAVO FLESSIBILE ESTERNO DI QUESTO APPARECCHIO VIENE DANNEGGIATO DEVE ESSERE SOSTITUITO DAL COSTRUTTORE O DAL SUO SERVIZIO ASSISTENZA O DA PERSONALE QUALIFICATO EQUIVALENTE AL FINE DI EVITARE PERICOLI

IF THE EXTERNAL FLEXIBLE CABLE OF THIS LUMINAIRE IS DAMAGED, IT SHALL BE EXCLUSIVELY REPLACED BY THE MANUFACTURER OR HIS SERVICE AGENT OR A SIMILAR QUALIFIED PERSON IN ORDER TO AVOID HAZARDS

1

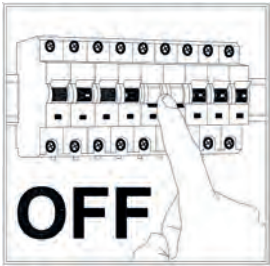

2

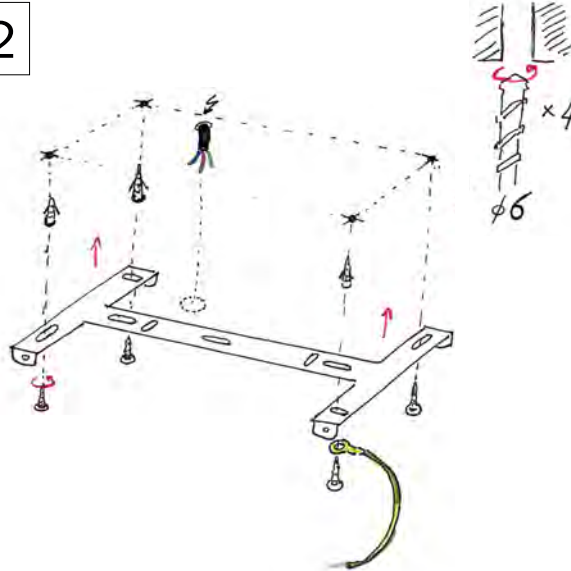

3

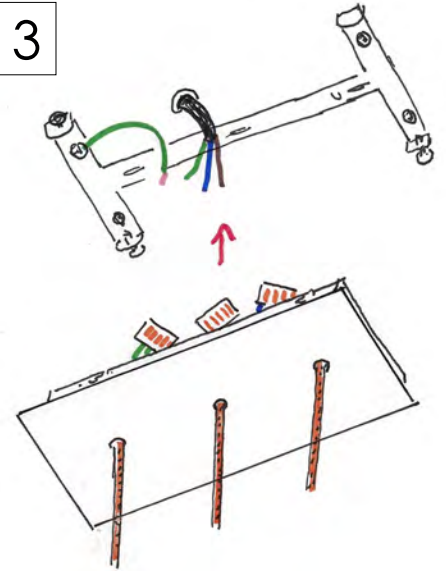

4

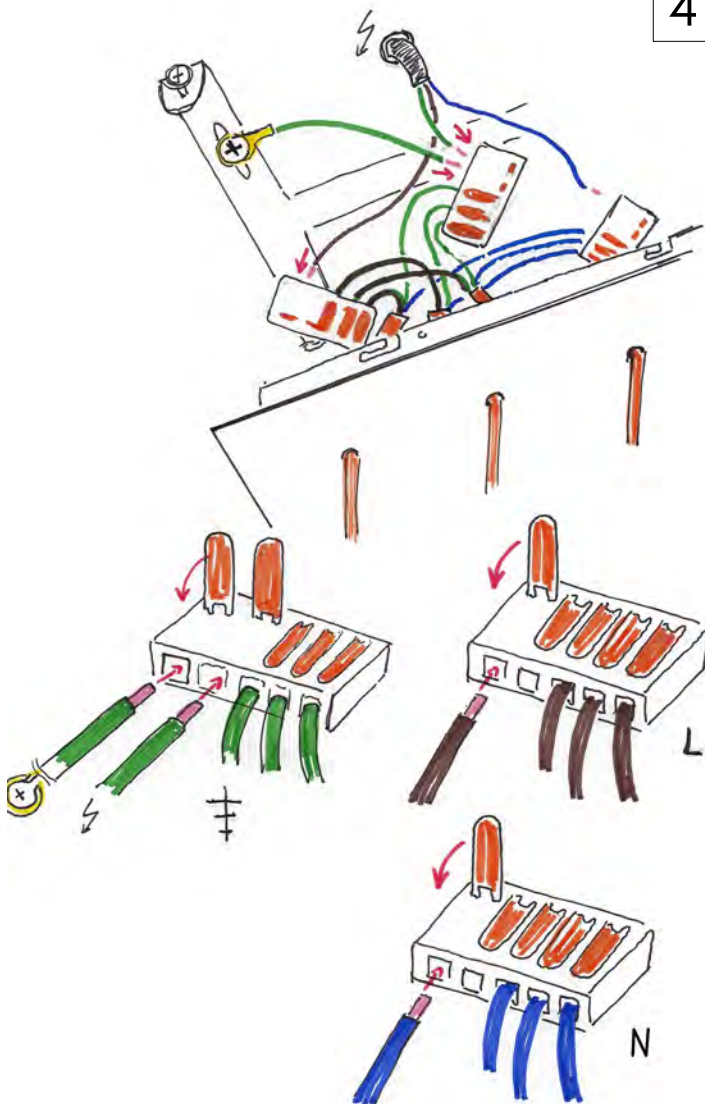

5



6

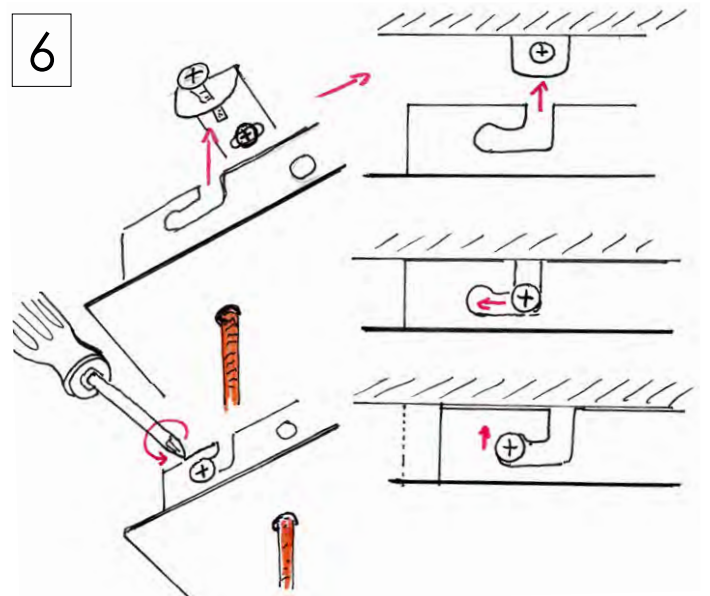

7

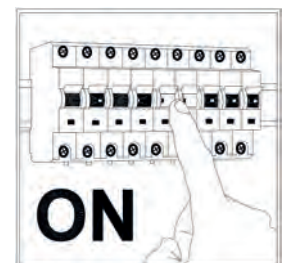

ITEM

Lampada a sospensione multipla
con Rose-one rettangolare
Multi-pendant lamp
with rectangular Rose-one

SPM7RE

220 - 240V
MAX 7 x 25W

CL. I CE 

SE IL CAVO FLESSIBILE ESTERNO DI QUESTO APPARECCHIO VIENE DANNEGGIATO DEVE ESSERE SOSTITUITO DAL COSTRUTTORE O DAL SUO SERVIZIO ASSISTENZA O DA PERSONALE QUALIFICATO EQUIVALENTE AL FINE DI EVITARE PERICOLI

IF THE EXTERNAL FLEXIBLE CABLE OF THIS LUMINAIRE IS DAMAGED, IT SHALL BE EXCLUSIVELY REPLACED BY THE MANUFACTURER OR HIS SERVICE AGENT OR A SIMILAR QUALIFIED PERSON IN ORDER TO AVOID HAZARDS

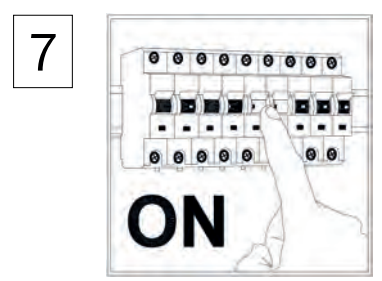
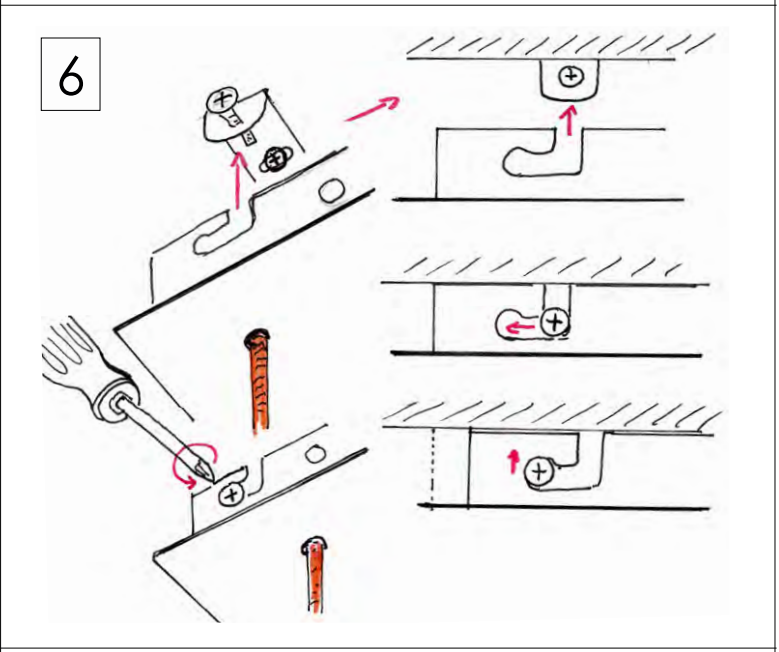
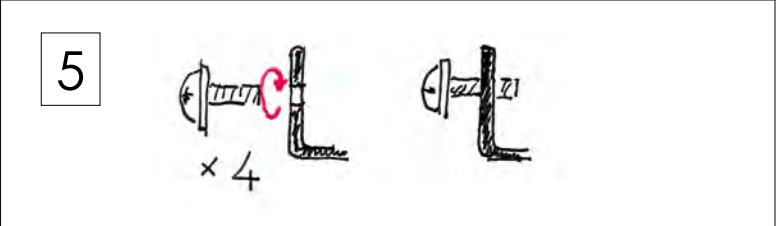
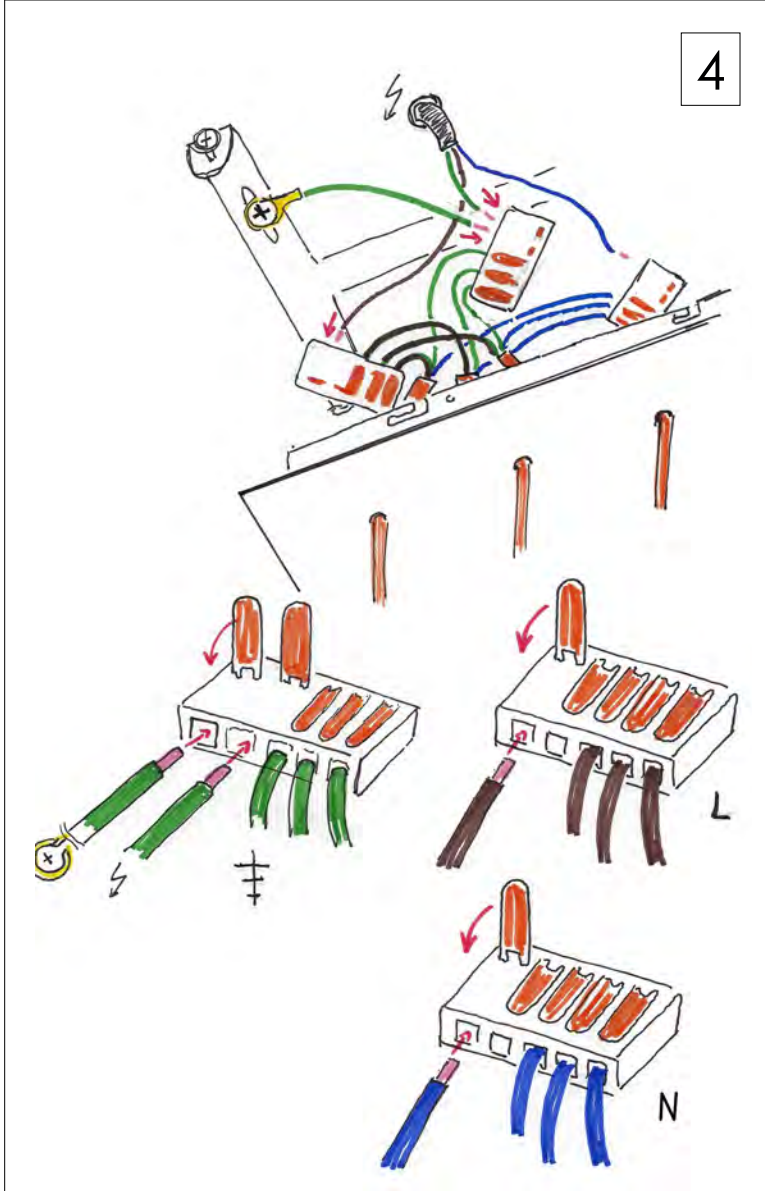
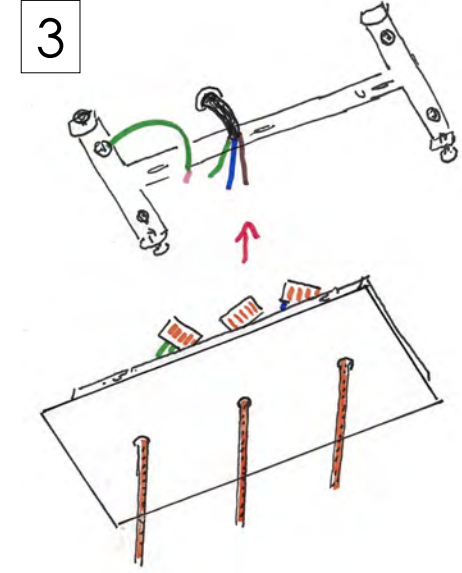
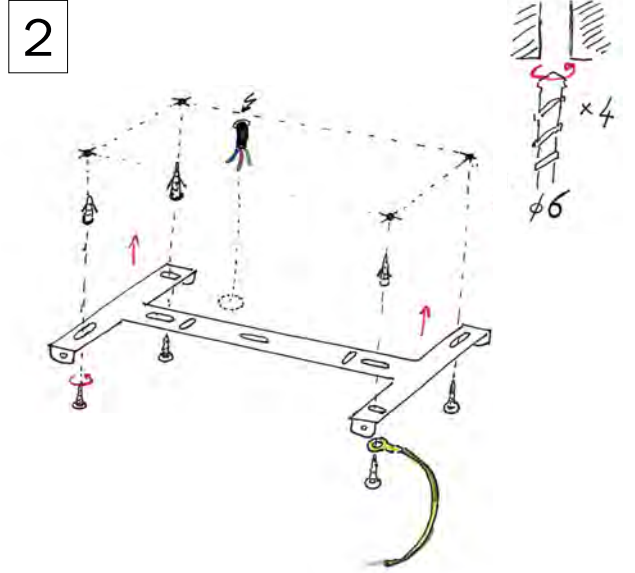
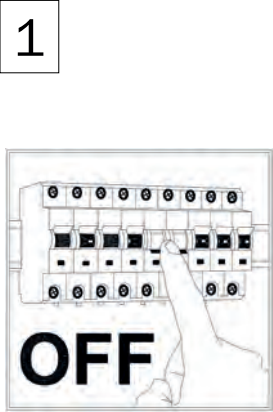

ITEM

Lampada a sospensione multipla
con Rose-one rettangolare
Multi-pendant lamp
with rectangular Rose-one

SPM8RE

220 - 240V
MAX 8 x 25W

CL. I CE 

SE IL CAVO FLESSIBILE ESTERNO DI QUESTO APPARECCHIO VIENE DANNEGGIATO
DEVE ESSERE SOSTITUITO DAL COSTRUTTORE O DAL SUO SERVIZIO ASSISTENZA
O DA PERSONALE QUALIFICATO EQUIVALENTE AL FINE DI EVITARE PERICOLI

IF THE EXTERNAL FLEXIBLE CABLE OF THIS LUMINAIRE IS DAMAGED, IT SHALL BE
EXCLUSIVELY REPLACED BY THE MANUFACTURER OR HIS SERVICE AGENT OR
A SIMILAR QUALIFIED PERSON IN ORDER TO AVOID HAZARDS

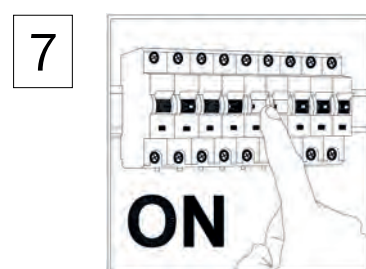
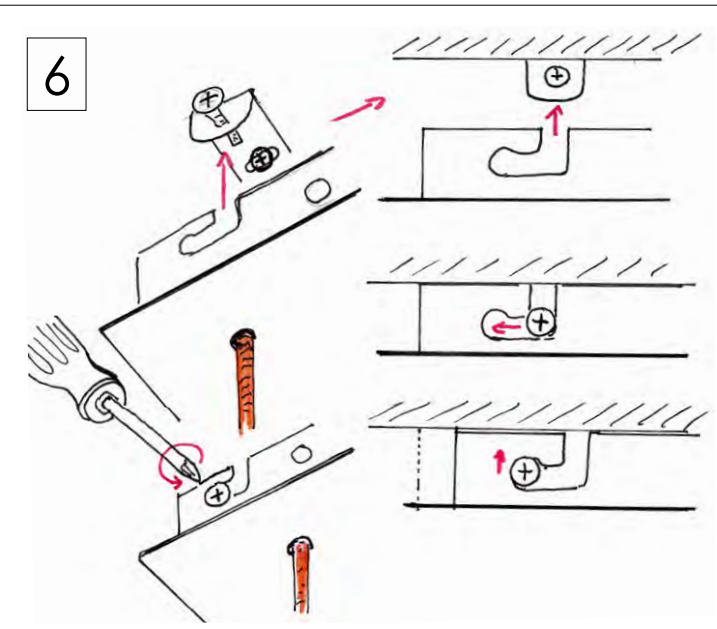
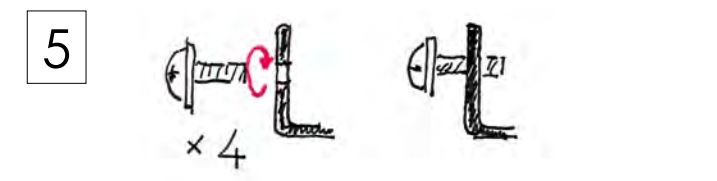
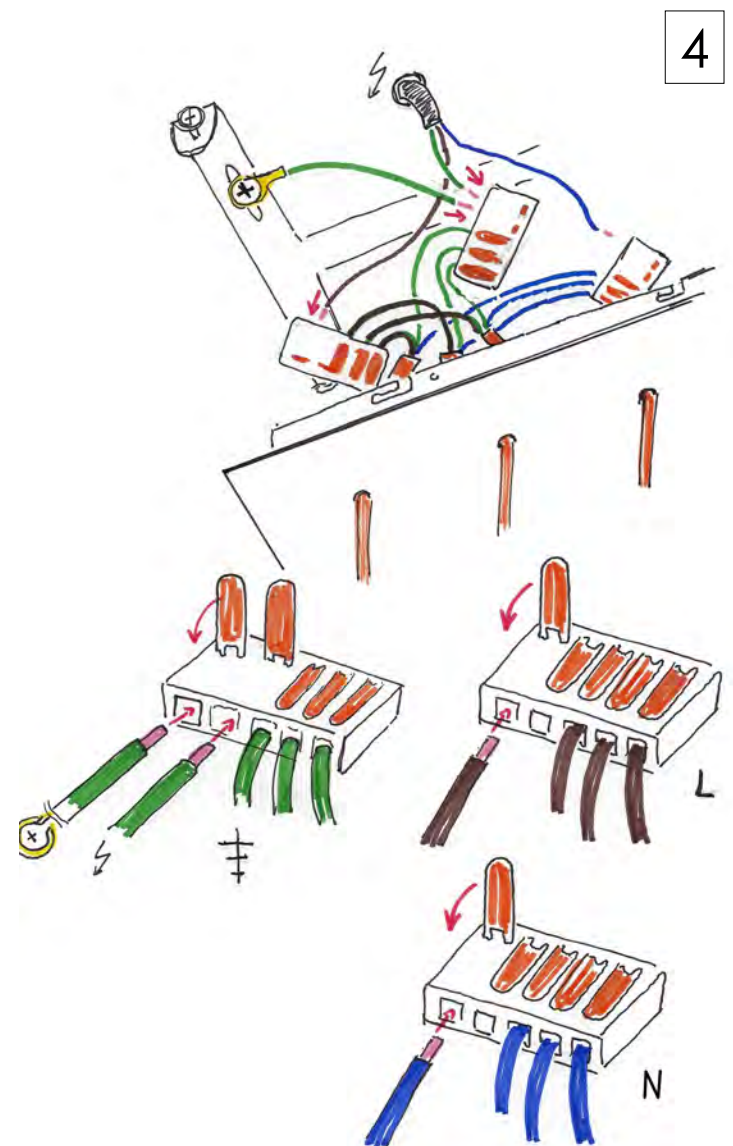
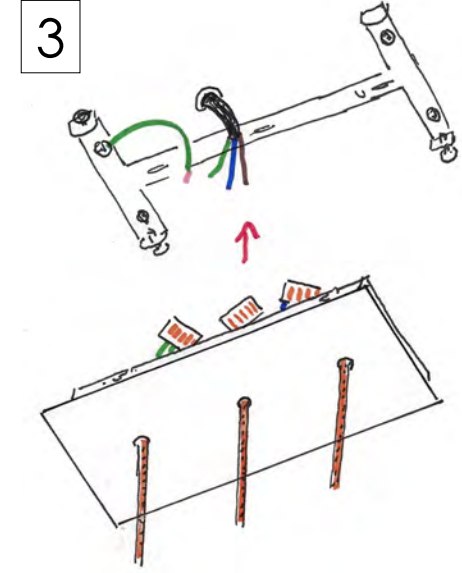
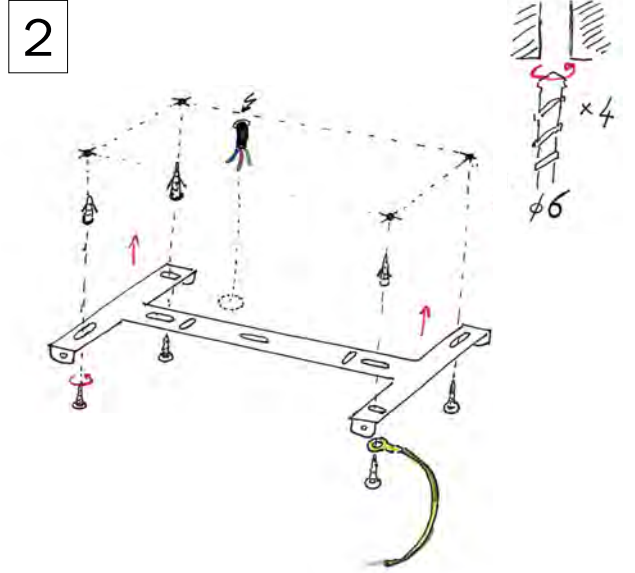
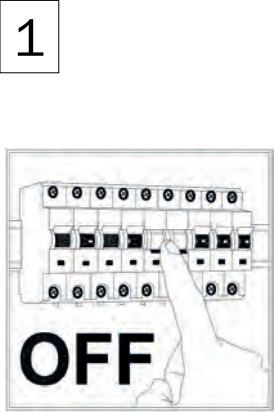

ITEM

Lampada a sospensione multipla
con Rose-one rettangolare
Multi-pendant lamp
with rectangular Rose-one

SPM11RE

220 - 240V
MAX 11 x 25W

CL. I CE 

SE IL CAVO FLESSIBILE ESTERNO DI QUESTO APPARECCHIO VIENE DANNEGGIATO
DEVE ESSERE SOSTITUITO DAL COSTRUTTORE O DAL SUO SERVIZIO ASSISTENZA
O DA PERSONALE QUALIFICATO EQUIVALENTE AL FINE DI EVITARE PERICOLI

IF THE EXTERNAL FLEXIBLE CABLE OF THIS LUMINAIRE IS DAMAGED, IT SHALL BE
EXCLUSIVELY REPLACED BY THE MANUFACTURER OR HIS SERVICE AGENT OR
A SIMILAR QUALIFIED PERSON IN ORDER TO AVOID HAZARDS

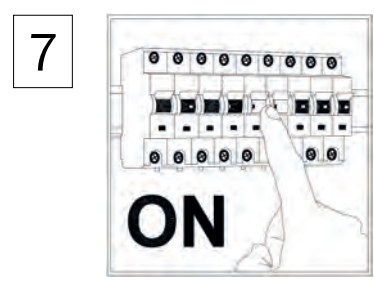
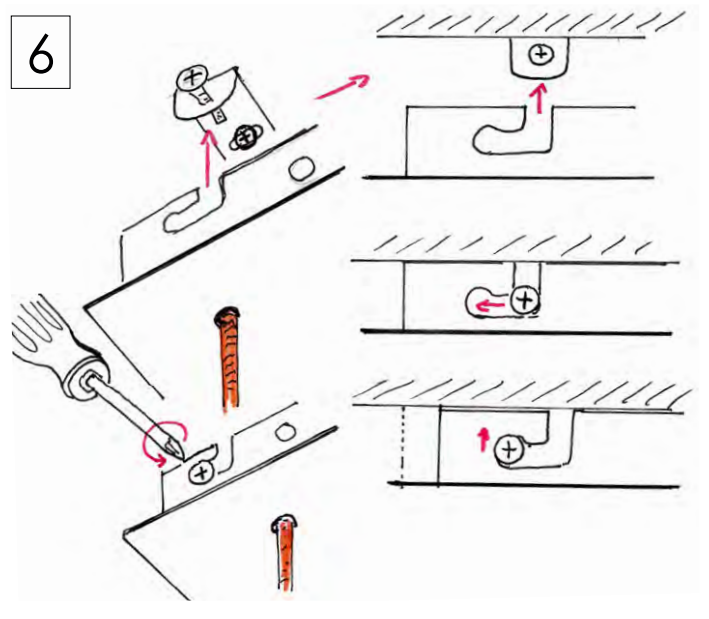
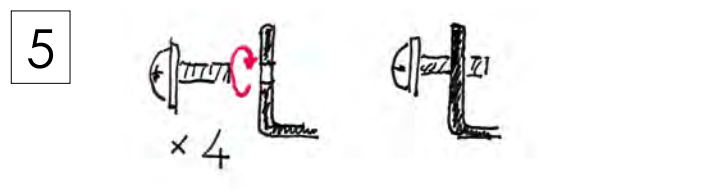
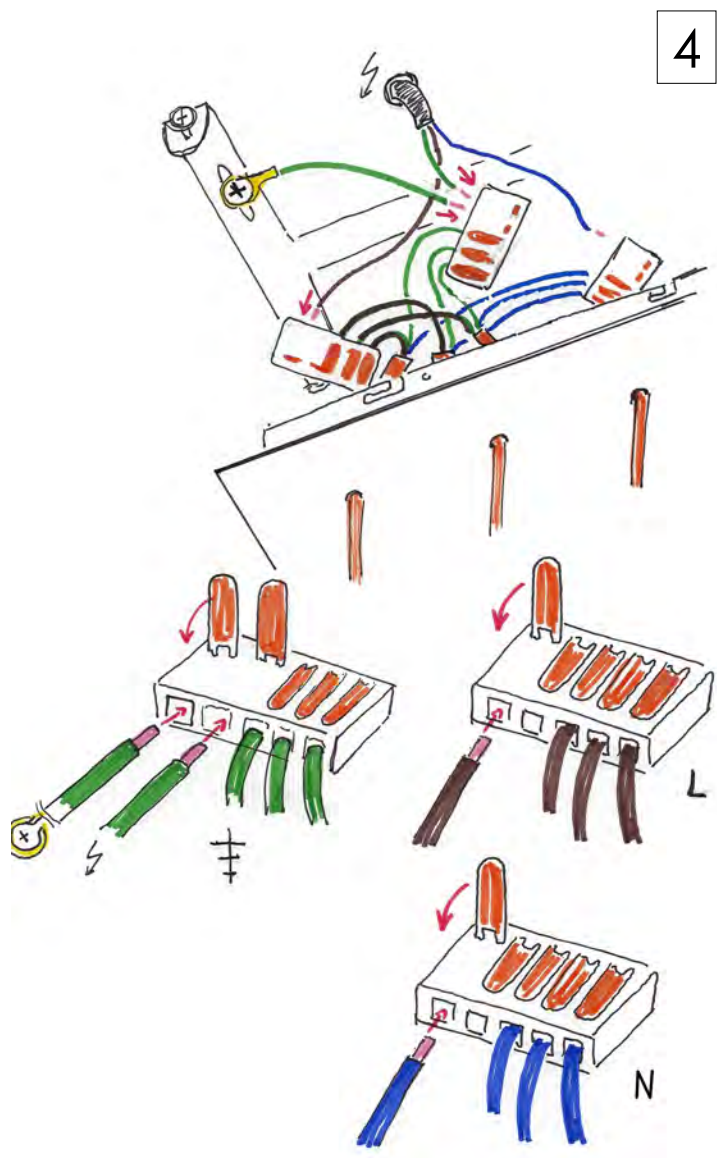
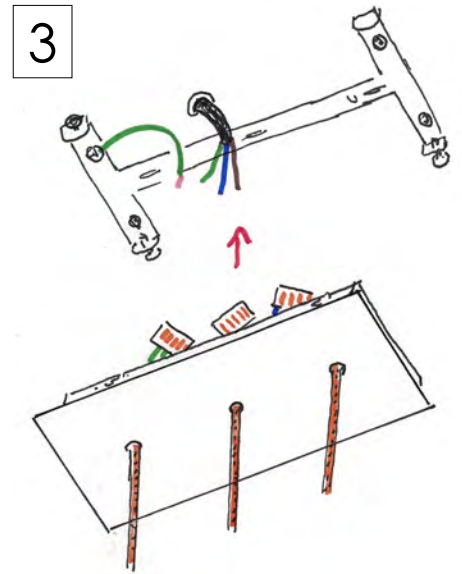
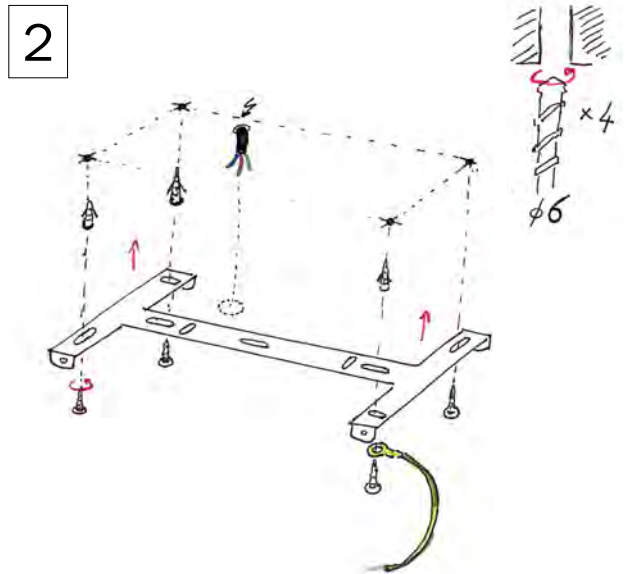
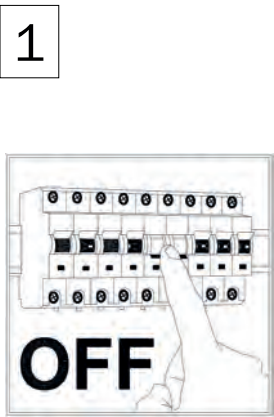

ITEM

Lampada a sospensione multipla
con Rose-one rettangolare
Multi-pendant lamp
with rectangular Rose-one

SPM14RE

220 - 240V
MAX 14 x 25W

CL. I CE 

SE IL CAVO FLESSIBILE ESTERNO DI QUESTO APPARECCHIO VIENE DANNEGGIATO
DEVE ESSERE SOSTITUITO DAL COSTRUTTORE O DAL SUO SERVIZIO ASSISTENZA
O DA PERSONALE QUALIFICATO EQUIVALENTE AL FINE DI EVITARE PERICOLI

IF THE EXTERNAL FLEXIBLE CABLE OF THIS LUMINAIRE IS DAMAGED, IT SHALL BE
EXCLUSIVELY REPLACED BY THE MANUFACTURER OR HIS SERVICE AGENT OR
A SIMILAR QUALIFIED PERSON IN ORDER TO AVOID HAZARDS

1

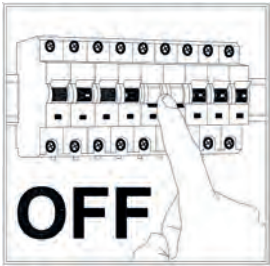

2

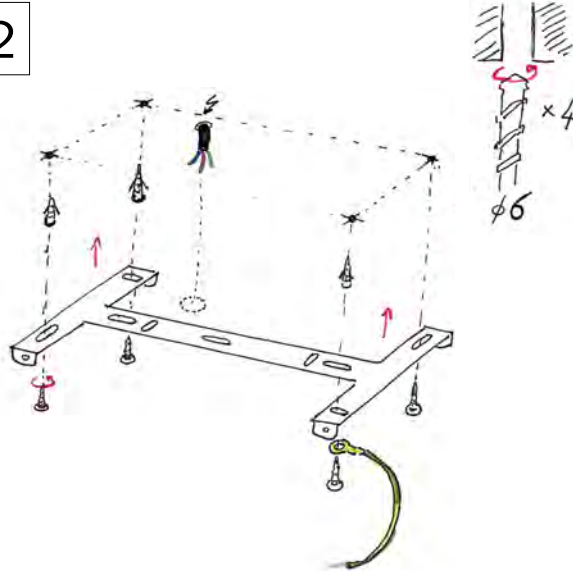

3

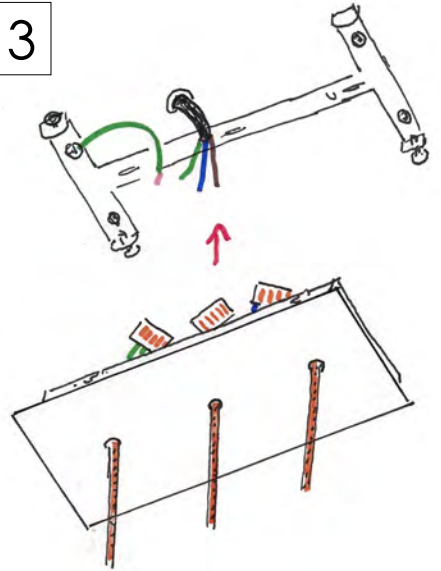

4

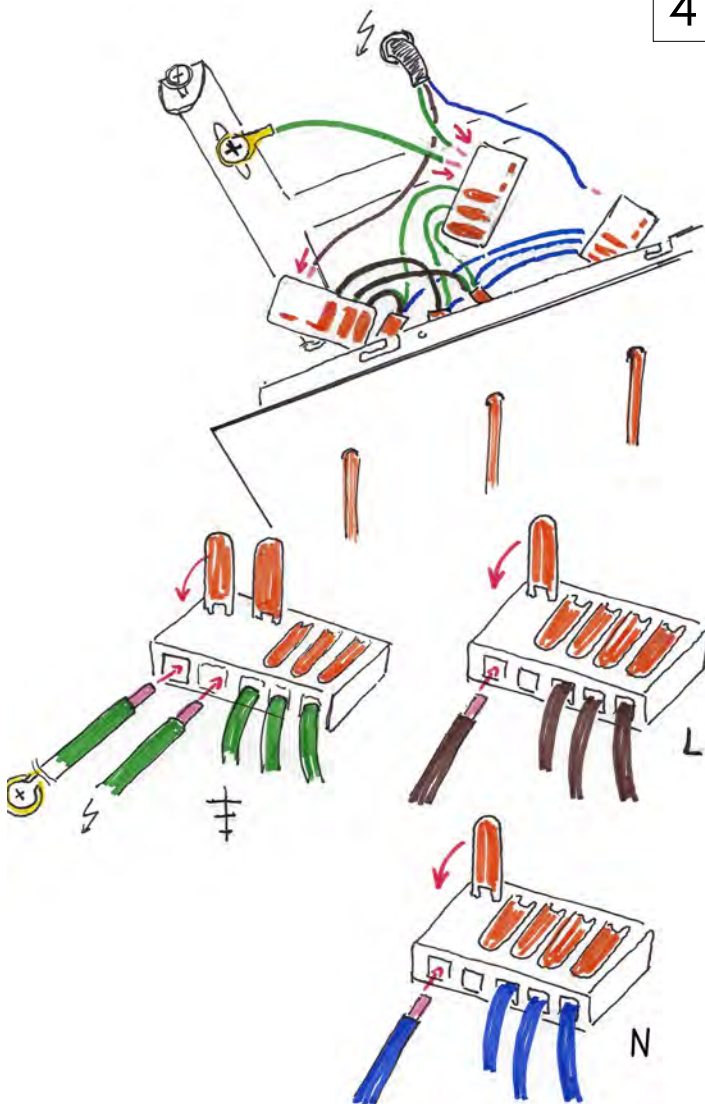

5



6

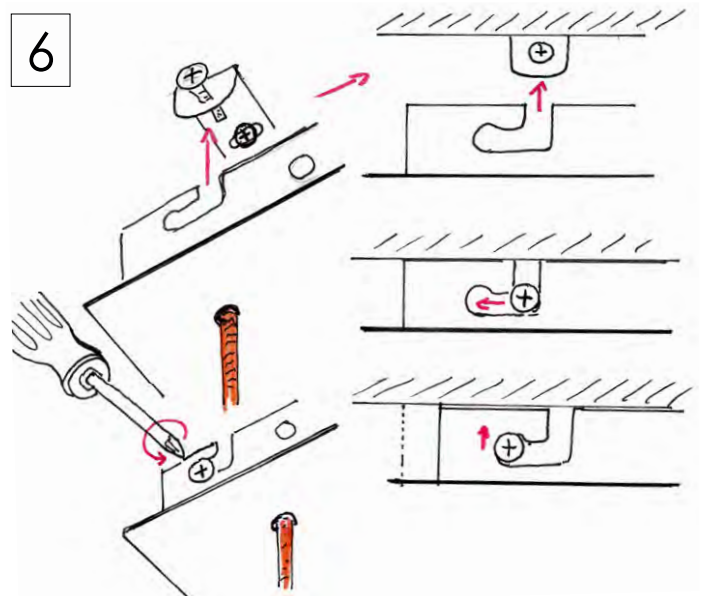

7

