

220 - 240V

6 x 105W E27

CL. I  

SE IL CAVO FLESSIBILE ESTERNO DI QUESTO APPARECCHIO VIENE DANNEGGIATO DEVE ESSERE SOSTITUITO DAL COSTRUTTORE O DAL SUO SERVIZIO ASSISTENZA O DA PERSONALE QUALIFICATO EQUIVALENTE AL FINE DI EVITARE PERICOLI!

IF THE EXTERNAL FLEXIBLE CABLE OF THIS LUMINAIRE IS DAMAGED, IT SHALL BE EXCLUSIVELY REPLACED BY THE MANUFACTURER OR HIS SERVICE AGENT OR A SIMILAR QUALIFIED PERSON IN ORDER TO AVOID HAZARDS

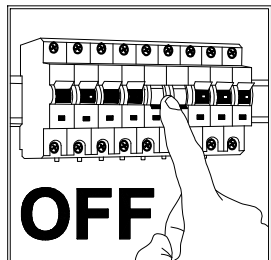

1

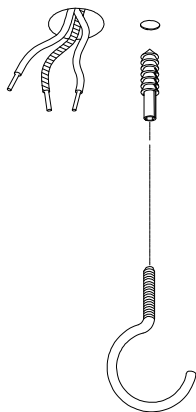

2

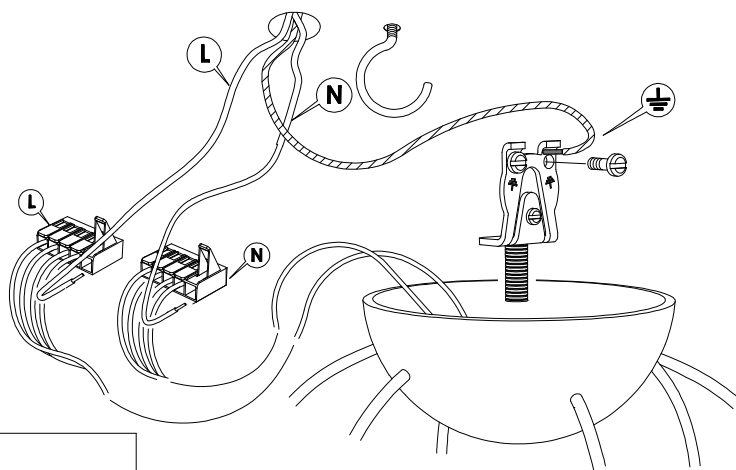

3

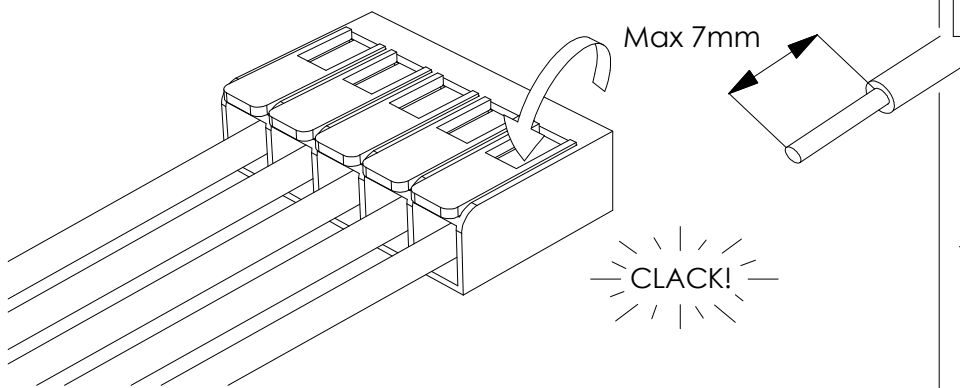

4

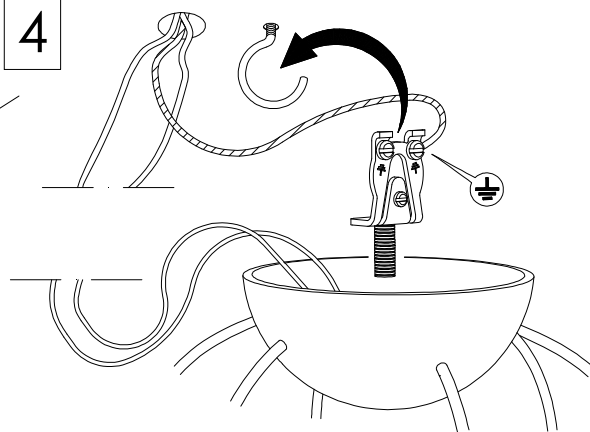

5

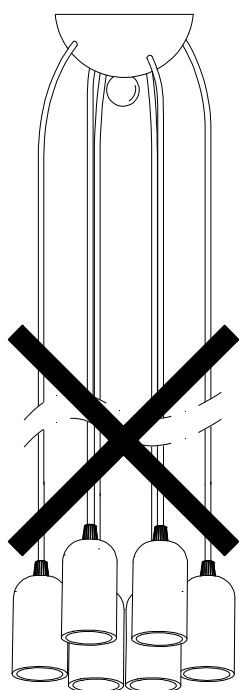
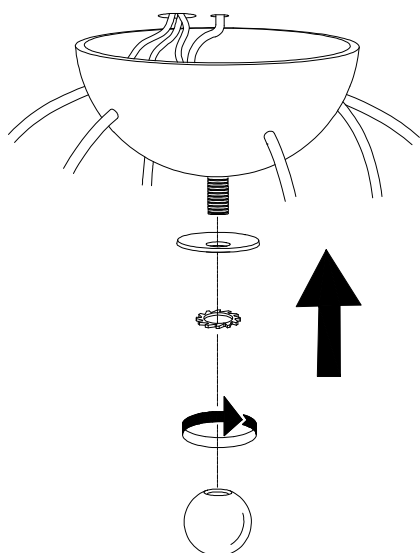

NO

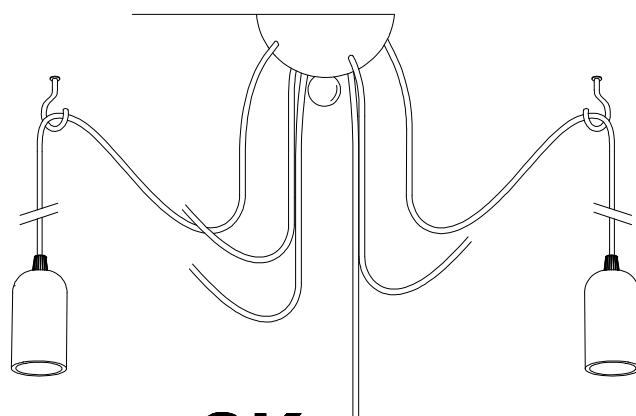

OK

