

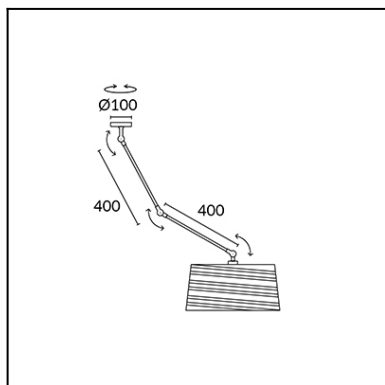

The photograph may not match the reference exactly. Please read the product description to identify the finish.

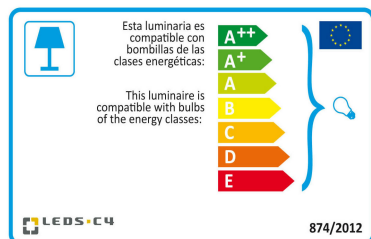

[Download photometric file .ldt / .ies](#)



[Click on image to download energy label](#)

TECHNICAL CHARACTERISTICS

Type:	Wall fixture/Pendant
Adjustable:	Adjustable 355° on the vertical axis.2 Adjustable 355° on the horizontal axis.
IP Protection degrees:	IP20
Light source 1:	1 x E27 MAX 100W
Total power consumption (W):	100
Voltage / Frequency:	220-240V/50-60Hz
Warranty (Years):	2
Units per box:	8
Net Weight (Kg):	0.815
EAN:	8435381409852



MATERIALS / FINISHES

Structure material: Steel

Structure finish: Satin nickel
Chrome

OPTIONAL ACCESSORIES

PAN-163-05



Shade, black horizontal wrapping, Ø330mm

Structure material:	Steel
Diffuser material:	Ribboned shade PVC
Diffuser finish:	Black

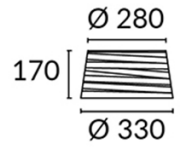

IP20 

PAN-163-14



Shade, white horizontal wrapping, Ø330mm

Structure material:	Steel
Diffuser material:	Ribboned shade PVC
Diffuser finish:	White

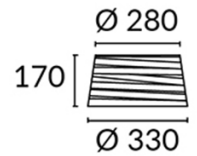

IP20 

PAN-164-05



Shade, black horizontal wrapping, Ø450mm

Structure material:	Steel
Diffuser material:	Ribboned shade PVC
Diffuser finish:	Black

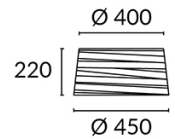

IP20 

PAN-164-14



Shade, white horizontal wrapping, Ø450mm

Structure material:	Steel
Diffuser material:	Ribboned shade PVC
Diffuser finish:	White

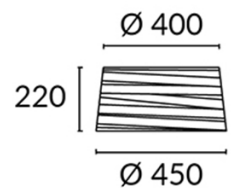

IP20 

PAN-174-05



Shade, black, Ø450mm

Structure material: Steel
Diffuser material: Fabric shade
Diffuser finish: Black

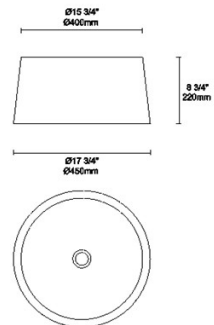

RF 850°C

PAN-174-14



Shade, white, Ø450mm

Structure material: Steel
Diffuser material: Fabric shade
Diffuser finish: White

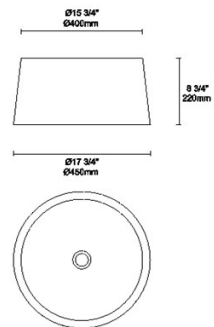

RF 850°C

PAN-219-05



Shade, black horizontal wrapping, Ø200mm

Structure material: Steel
Structure finish: White
Diffuser material: Ribbed shade
 PVC
Diffuser finish: Black

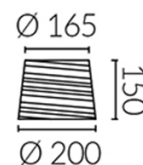

IP20 RF 850°C

PAN-219-14



Shade, white, horizontal wrapping, Ø200mm

Structure material: Steel
Structure finish: White
Diffuser material: Ribbed shade
 PVC
Diffuser finish: White

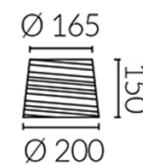

IP20 RF 850°C

